

1.4.2.3 Standard Customized Solutions (OEM) Thermal Sensors

60mW to 100W

Features

- Conduction cooled
- Spectrally flat
- Standard UAF version can give analog voltage output or digital RS232 output and can measure power or single shot energy. Can also have multiple switchable ranges and/or multiple switchable wavelengths
- UAU and UAE versions are similar to the UAF version but UAU operates via the USB terminal of the PC and UAE via an Ethernet connection

100C-BB-18-SH / 100C-UAF / 100C-UAU / 100C-UAE



These specifications refer to standard OEM sensors, and are to be understood as generic, describing sensor families. Ophir will be happy to help you with a specific solution for your particular application.

Model	100C-BB-18-SH	100C-UAF / 100C-UAU / 100C-UAE
Type	Smart sensor	UAF – Analog or RS232 output UAU – USB compatible output UAE – Ethernet output
Features	Low profile, smart sensor	Low profile, various outputs
Absorber Type	Broadband	Broadband
Spectral Range μm	0.19 - 11	0.19 - 11 ^(c)
Absorption	~88%	~88%
Aperture mm	$\varnothing 18$	$\varnothing 18$
Power Mode		
Maximum power ^(a)	4W continuous, 20W for 1.8 min	4W continuous, 20W for 1.8 min
free standing	100W	100W
heat sinked	60mW	60mW
Minimum power	60mW	60mW
Power Noise Level	3mW	3mW
Maximum Average Power Density kW/cm ²	30 at 4W 14 at 100W	30 at 4W 14 at 100W
Response Time (0-95%), typ. (sec)	1.2s	1.2s
Calibration Uncertainty $\pm\%$	1.9	1.9
Power Accuracy $\pm\%$ at calibration wavelength	3 ^(d)	3 ^(d)
Linearity with Power $\pm\%$	1	1
Amplifier power supply	NA	UAF +6V to +24V UAU - Via Host USB UAE +6V to +24V via separate connector
Energy Mode		
Maximum Energy	NA	NA
Minimum Energy	NA	NA
Maximum Energy Density J/cm ²		
<100ns	0.3	0.3
0.5ms	5	5
2ms	10	10
10ms	30	30
Cooling	Conduction	Conduction
Connections	Ophir smart plug	UAF - 6 pin Molex ^(b) UAU - Mini B USB connector UAE - Ethernet for communications and 5 pin for power
Dimensions	48x48x14.5mm	48x48x14.5mm
Compliance	CE, UKCA, China RoHS	RoHS, China RoHS
Version	V1	
Part number	7Z07126	Consult Ophir Representative
Note: (a)	With analog "UAF" versions, sensor voltage output is accurate up to 2v below lowest level of supply voltage, taking into account supply voltage ripple	
Note: (b)	6 pin Molex connections: RS232 input, Ground, +Voltage, Analog signal out, high/low voltage or switch input when used, RS232 output	
Note: (c)	Calibrated at customer selected wavelength	
Note: (d)	$\pm 4\%$. For wavelengths <240nm	

* For drawings please see page 154

* For UAE & UAU drawings please see pages 159-160

100C-BB-18-SH

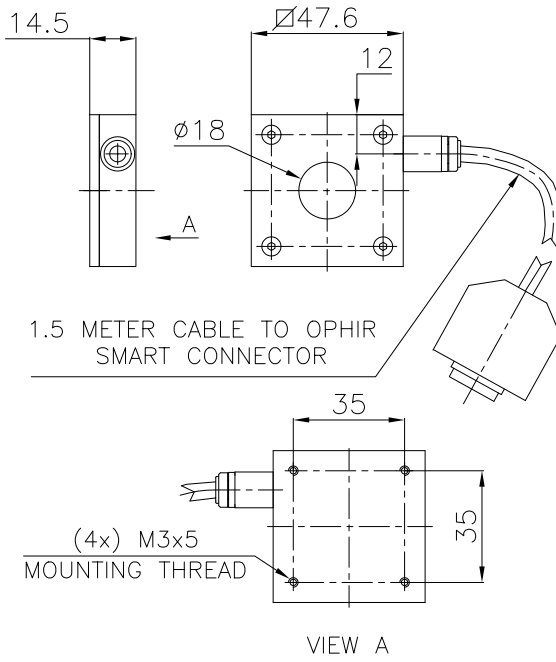

100C-UAF

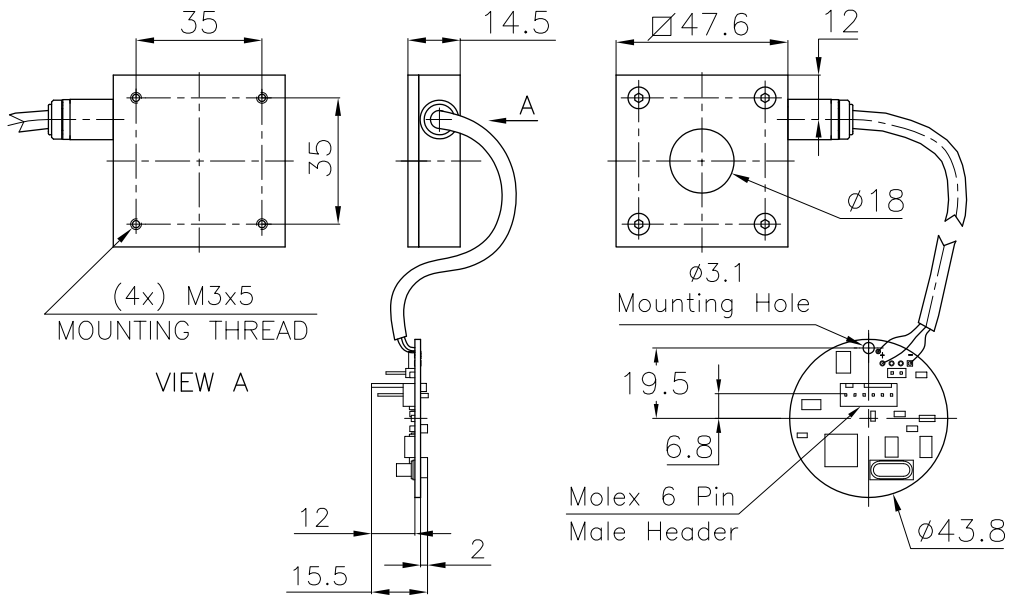

UAE Drawings

20C-UAE

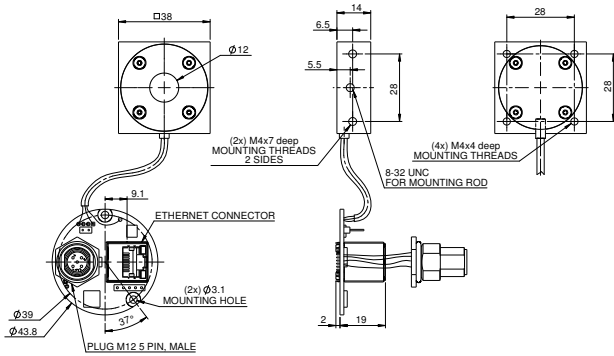

L30C-UAE

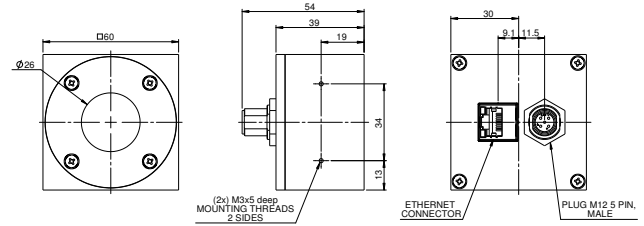

100C-UAE

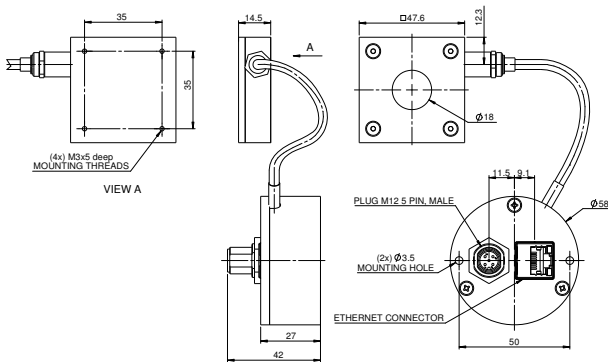

150C-UAE

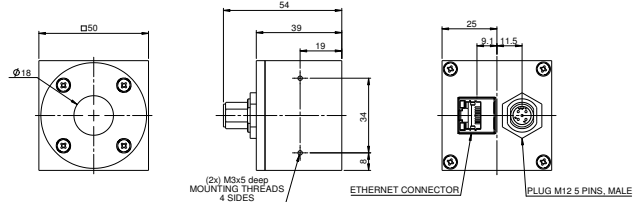

150W-UAE

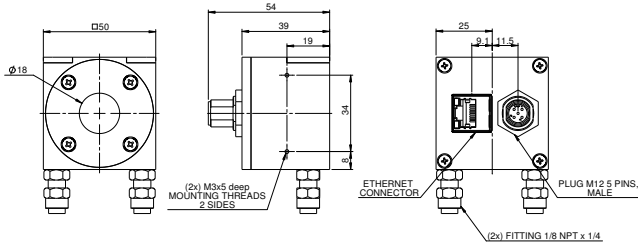

L150C-UAE

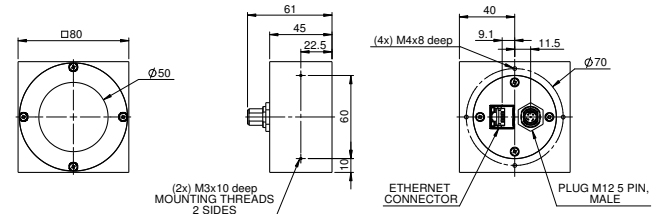

L250W-UAE / L300W-UAE

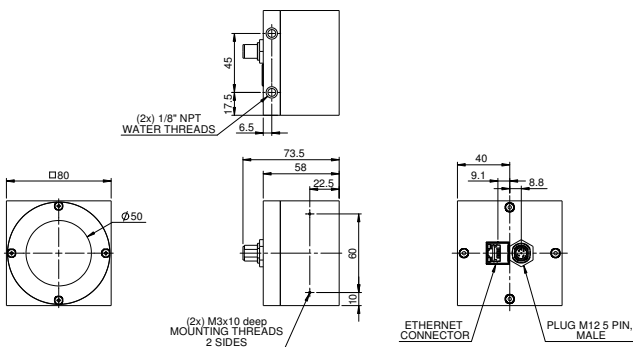

600W-UAE

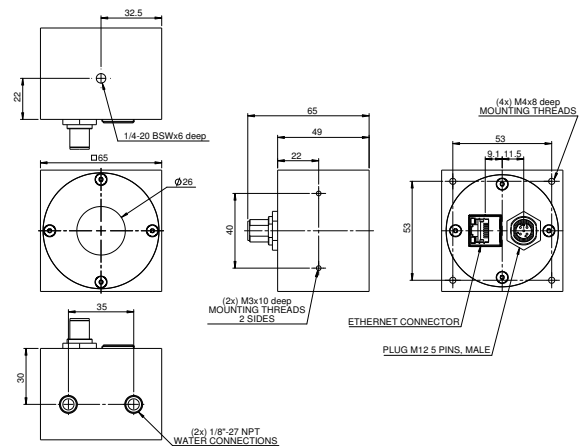

UAU Drawings

20C-UAU

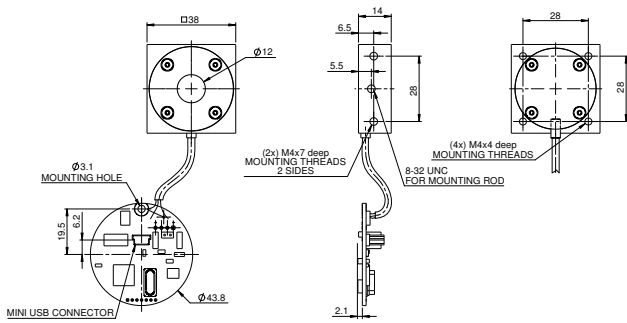

L30C-UAU

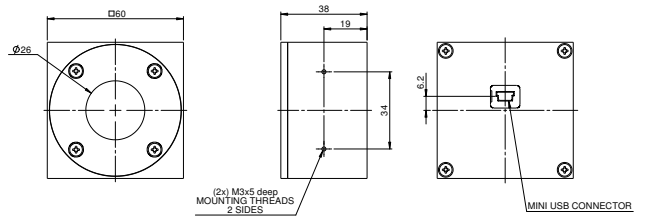

100C-UAU

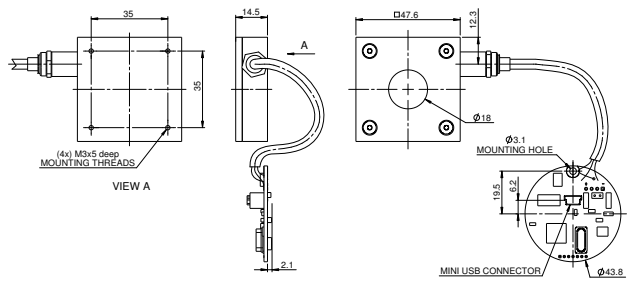

150C-UAU

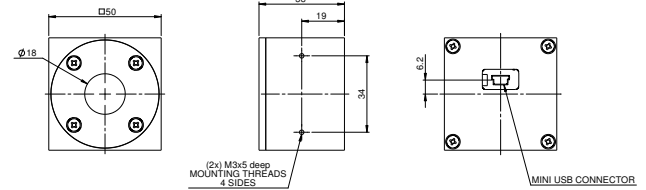

150W-UAU

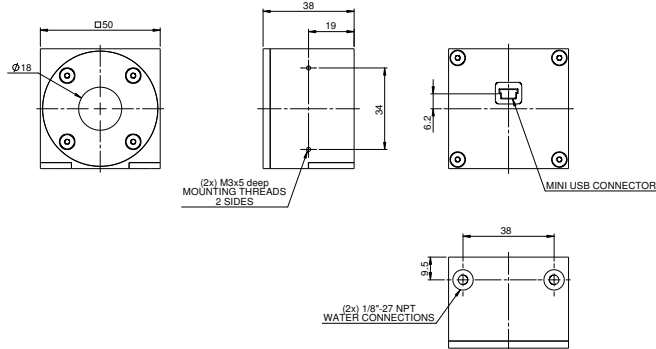

L150C-UAU

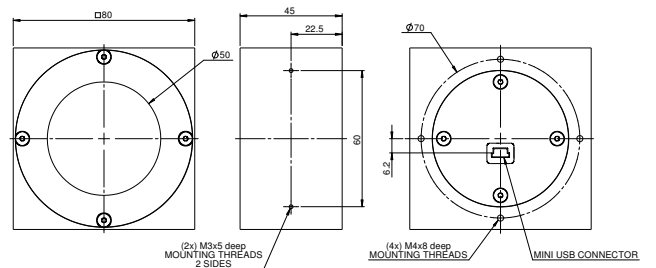

L250W-UAU / L300W-UAU

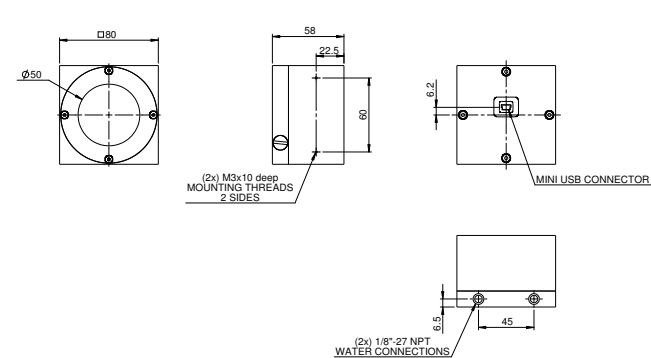

600W-UAU

